



Republic of the Philippines
Province of Pampanga

Bids and Awards Committee

Provincial Capitol, City of San Fernando, (P) / (045) 435-5901

DEC 0 2 2024

RFQ No. **241229**

P.R. No. / Date / End User / Purpose:

(24-5724 11/13/2024 PROVINCIAL ENGINEER'S OFFICE To supply materials including installation for Three (3) Units Deep Well at Palimpe, Masantol, Pampanga as per approved Program of Work, Plans and Specifications.)

REQUEST FOR QUOTATION

Small Value Procurement

Company Name: ARGC CONSTRUCTION + TRADING
Address: SAN SIMON, PAMPANGA
Tel. No.: _____

Please quote your lowest price for the requirements listed hereunder subject to the Terms and Conditions stated below and submit to this Office duly signed by you or your representative not later than **9:00 a.m. DEC 0 6 2024**

APPROVED BUDGET FOR
THE CONTRACT (ABC):
Php 318,894.03

FRANCIS V. MASLOG
CHAIRPERSON
Bids and Awards Committee

TERMS AND CONDITIONS

- All quotations may be typewritten or handwritten, placed in a sealed envelope.
- All quotations shall be valid for one hundred twenty (120) calendar days from the deadline of the submission of the same.
- Any erasures or overwriting shall be valid only if they are signed or initialed by the supplier or its authorized representative.
- Interested suppliers are required to submit their valid current Mayor's Permit, PhilGEPS Registration Number, and Income/BIR Tax Return (for ABCs above P500,000.00) upon submission of quotation. In lieu of the Mayor's Permit and PhilGEPS Registration Number, the PhilGEPS Certificate of Platinum Membership may be submitted. For new businesses, submit the BIR Certificate of Registration and latest quarterly return or percentage tax..
- The applicable rate for late deliveries is one tenth (1/10) of one percent (1%) of the cost of the unperformed portion for everyday of delay.
- The Provincial Government of Pampanga reserves the right to accept or reject any quotation, and to annul the procurement process and reject all quotations at any time prior to contract award, without thereby incurring any liability to the affected supplier/s.
- The PGP also reserves the right to waive any required formality in the proposals received, and select the proposal which it determine to be the most advantageous to the government.

Item No.	Qty	Unit	Item Description	Unit Price	Total Price
1	9	pcs	2" GI Pipe	3,000	27,000
2	39	pcs	1-1/4" GI Pipe	1,500	58,500
3	9	pcs	1" GI Pipe	1,200	10,800
4	9	pcs	2" GI Coupling	300	2,700
5	39	pcs	1-1/4" Coupling	200	7,800
6	9	pcs	1" Coupling	150	1,350
7	3	set	Hand Pump Set	6,500	19,500
8	12	bags	Cement	230	2,760
9	1	cu.m	Sand	1,600	1,600
10	1.50	cu.m	Gravel	2,600	3,900
11	24	pcs	10mm Reinforcing Steel Bars	240	5,760
12	1	l.s	Drilling and Installation Cost	177,200	177,200

Total Lot Price

318,870.00

Note: The winning supplier shall submit a duly signed and notarized Omnibus Sworn Statement prior to notice of award.

DEC 02 2024

THE BIDS AWARDS COMMITTEE:

Having carefully read and accepted your Terms and Conditions, including the technical specifications, I/We offer to supply/deliver the item/s as noted above.



JOSEPHINE ANNE CANLAS

Supplier's authorized representative signature over printed name

Designation: PROPRIETOR

Contact No.: _____

Email Address.: _____

ARCHIMEDES R. DIZON
May



View Red Registration

Back (<https://www.philgens.gov.ph/MyDashboards/MyRedView>)

My Contact Details

Salutation	Ms	First Name	JOSEPHINE ANNE
Middle Name	DAYRIT	Last Name	CANLAS
Gender	Female	Position	PROPRIETOR
Landline Area Code	045	Landline Number	6526051
Landline Extension Number			
Fax Area Code		Fax Number	
Fax Extension Number			
Country Code	63	Mobile Number	9967561722
Email Address	argomanpower@yahoo.com		

Organization Details

Organization Id	271285	Registration Date	17-Sep-2021 09:54 AM
Registration Status	active		
Organization Name	ARGO CONSTRUCTION AND TRADING	Form Of Organization	Single Proprietorship
Business Category	Heavy construction machinery and equipment, Structural building products		
Location	local	Organization Type	General Contractor, Services, Trading
Business Tax Identification Number	271580109000	Capitalization	₱ 5,000,000.00

Single Proprietorship Details

DTI Certificate Number	2643375	DTI Registration Date	11-Feb-2021
Expiration Date	11-Feb-2026	DTI Business Scope	city/municipality
Signatory	Josephine Anne Canlas		

Local Organization Address

Philippines

Region III

<https://www.philgens.gov.ph/MyDashboards/MyRedView/271285>

2022-09-03 AM
Page 1 of 2



Republic of the Philippines
Province of Pampanga

Bids and Awards Committee

Provincial Capitol, City of San Fernando, (P) / (045) 435-5901

DEC 0 2 2024

RFQ No. **241229**

P.R. No. / Date / End User / Purpose:

(24-5724 11/13/2024 PROVINCIAL ENGINEER'S OFFICE To supply materials including installation for Three (3) Units Deep Well at Palimpe, Masantol, Pampanga as per approved Program of Work, Plans and Specifications.)

REQUEST FOR QUOTATION

Small Value Procurement

Company Name: MAM CONSTRUCTION AND TRADING
Address: STA. CRUZ, LUBAO, P.
Tel. No.: _____

Please quote your lowest price for the requirements listed hereunder subject to the Terms and Conditions stated below and submit to this Office duly signed by you or your representative not later than 9:00 a.m. DEC 0 6 2024

APPROVED BUDGET FOR
THE CONTRACT (ABC):
Php 318,894.03

FRANCIS V. MASLOG
CHAIRPERSON
Bids and Awards Committee

TERMS AND CONDITIONS

- All quotations may be typewritten or handwritten, placed in a sealed envelope.
- All quotations shall be valid for one hundred twenty (120) calendar days from the deadline of the submission of the same.
- Any erasures or overwriting shall be valid only if they are signed or initialed by the supplier or its authorized representative.
- Interested suppliers are required to submit their valid current Mayor's Permit, PhilGEPS Registration Number, and Income/BIR Tax Return (for ABCs above P500,000.00) upon submission of quotation. In lieu of the Mayor's Permit and PhilGEPS Registration Number, the PhilGEPS Certificate of Platinum Membership may be submitted. For new businesses, submit the BIR Certificate of Registration and latest quarterly return or percentage tax..
- The applicable rate for late deliveries is one tenth (1/10) of one percent (1%) of the cost of the unperformed portion for everyday of delay.
- The Provincial Government of Pampanga reserves the right to accept or reject any quotation, and to annul the procurement process and reject all quotations at any time prior to contract award, without thereby incurring any liability to the affected supplier/s.
- The PGP also reserves the right to waive any required formality in the proposals received, and select the proposal which it determine to be the most advantageous to the government.

Item No.	Qty	Unit	Item Description	Unit Price	Total Price
1	9	pcs	2" GI Pipe	2,900	26,100
2	39	pcs	1-1/4" GI Pipe	1,550	60,450
3	9	pcs	1" GI Pipe	1,250	11,250
4	9	pcs	2" GI Coupling	240	2,160
5	39	pcs	1-1/4" Coupling	200	7,800
6	9	pcs	1" Coupling	160	1,440
7	3	set	Hand Pump Set	6,200	18,600
8	12	bags	Cement	300	3,600
9	1	cu.m	Sand	1,700	1,700
10	1.50	cu.m	Gravel	2,550	3,825
11	24	pcs	10mm Reinforcing Steel Bars	250	6,000
12	1	l.s	Drilling and Installation Cost	175,960	175,960

Total Lot Price

₱318,885.00

Note: The winning supplier shall submit a duly signed and notarized Omnibus Sworn Statement prior to notice of award.

DEC 02 2024

THE BIDS AWARDS COMMITTEE:

Having carefully read and accepted your Terms and Conditions, including the technical specifications, I/We offer to supply/deliver the item/s as noted above.

JURIC PECSON

Supplier's authorized representative signature over printed name

Designation: _____

Contact No.: _____

Email Address.: _____

BAC CANVASSER

May

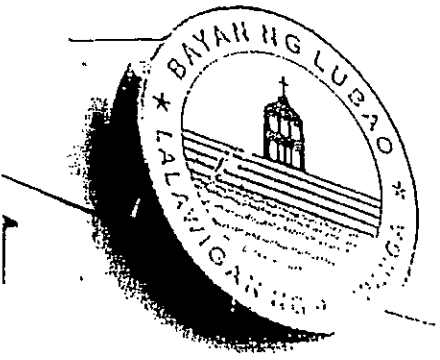

Republic of the Philippines
Province of Pampanga
Municipality of Lubao

RENEWAL

PERMIT NO. 2024-00050

BUSINESS PLATE NO. 0339

MAYOR'S PERMIT

This certifies that

MAM CONSTRUCTION & TRADING

Business Address: A MABINI, STA CRUZ, LUBAO

Taxpayer's Name: CELESTINO M. MACASPAC

Contact No: 971-67-45

Form of Ownership: SINGLE PROPRIETORSHIP

Nationality: PHILIPPINE

has been granted PERMIT to operate above-cited business/es pursuant to the REVENUE TAX CODE of LUBAO, PROVINCE OF PAMPANGA and after payment of taxes, fees and other regulatory charges and subject to the compliance of such other laws, ordinances and related administrative regulations.

2024

This permit is valid up to December 31, 2024, renewable on or before January 20 of each year unless sooner revoked.

Bin No 019-08-2014-0000414
 O.R. No 5325793
 O.R. Date 01/04/2024
 Fee Paid Ph 16,656.78

CONSTRUCTION SVCS
RETAILER (CONST SUPPLIES)

Approved by:

 HON JAY B. MONTEMAYOR
 ACTING MUNICIPAL MAYOR

HON. ESMERALDA G. PINEDA
MUNICIPAL MAYOR

NOTE:
 1. This PERMIT must be posted in conspicuous place.
 2. This PERMIT may be REVOKED for failure to comply with any of the existing Laws and Ordinances.
 3. This PERMIT shall be surrendered to the Office of the Treasurer (PTU) if the business ceases to operate.



Efficient Service Must Involve Equality

[My PhilGEPS](#)

[My Organization](#)

[My Profile](#)

[Opportunities](#)

[Catalogue](#)



Friday, November 17, 2023 12:59 PM

Organization Profile

MAM CONSTRUCTION AND TRADING

Sta. Cruz,
Lubao
Pampanga
Region III
Philippines

Organization Member Type:	Supplier
Organization Number:	33990
Registration Date:	25-Jan-2007
Registration Type:	Red
Form of Organization:	Single Proprietorship
Organization Type:	General Contractor
Business Category:	Construction Projects
Business Tax Identification Number:	171938244000
DTI Certificate Number:	00236209
DTI Registration Date:	27-Sep-2006
Agency Registration:	No
Blacklisted:	No

Contact

Marcos, Celestina Marcos

82 045 071874E



Bids and Awards Committee

Provincial Capitol, City of San Fernando, (P) / (045) 435-5901

DEC 02 2024

RFQ No. **241229**
P.R. No. / Date / End User / Purpose:
(24-5724 11/13/2024 PROVINCIAL ENGINEER'S OFFICE To supply materials including installation for Three (3) Units Deep Well at Palimpe, Masantol, Pampanga as per approved Program of Work, Plans and Specifications.)

REQUEST FOR QUOTATION

Small Value Procurement

Company Name: ROOMAC CONSTRUCTION AND TRADING
Address: STA. CRUZ, LUBAO, PAMPANGA
Tel. No.: 0908-340-8346

Please quote your lowest price for the requirements listed hereunder subject to the Terms and Conditions stated below and submit to this Office duly signed by you or your representative not later than 9:00 a.m. DEC 06 2024

APPROVED BUDGET FOR THE CONTRACT (ABC):
PHP 318,894.03

FRANCIS V. MASLOG
CHAIRPERSON
Bids and Awards Committee

TERMS AND CONDITIONS

- All quotations may be typewritten or handwritten, placed in a sealed envelope.
- All quotations shall be valid for one hundred twenty (120) calendar days from the deadline of the submission of the same.
- Any erasures or overwriting shall be valid only if they are signed or initialed by the supplier or its authorized representative.
- Interested suppliers are required to submit their valid current Mayor's Permit, PhilGEPS Registration Number, and Income/BIR Tax Return (for ABCs above P500,000.00) upon submission of quotation. In lieu of the Mayor's Permit and PhilGEPS Registration Number, the PhilGEPS Certificate of Platinum Membership may be submitted. For new businesses, submit the BIR Certificate of Registration and latest quarterly return or percentage tax..
- The applicable rate for late deliveries is one tenth (1/10) of one percent (1%) of the cost of the unperformed portion for everyday of delay.
- The Provincial Government of Pampanga reserves the right to accept or reject any quotation, and to annul the procurement process and reject all quotations at any time prior to contract award, without thereby incurring any liability to the affected supplier/s.
- The PGP also reserves the right to waive any required formality in the proposals received, and select the proposal which it determine to be the most advantageous to the government.

Item No.	Qty	Unit	Item Description	Unit Price	Total Price
1	9	pcs	2" GI Pipe ✓	₱ 2800.00	₱ 25,200.00
2	39	pcs	1-1/4" GI Pipe ✓	1,600.00	62,400.00
3	9	pcs	1" GI Pipe ✓	1,300.00	11,700.00
4	9	pcs	2" GI Coupling ✓	200.00	1,800.00
5	39	pcs	1-1/4" Coupling ✓	150.00	5,850.00
6	9	pcs	1" Coupling ✓	120.00	1,080.00
7	3	set	Hand Pump Set ✓	6,000.00	18,000.00
8	12	bags	Cement ✓	250.00	3,000.00
9	1	cu.m	Sand ✓	1500.00	1,500.00
10	1.50	cu.m	Gravel ✓	2,500.00	3,750.00
11	24	pcs	10mm Reinforcing Steel Bars ✓	200.00	4,800.00
12	1	l.s	Drilling and Installation Cost ✓	178,500.00	178,500.00

Total Lot Price ₱ **317,580.00**

Note: The winning supplier shall submit a duly signed and notarized Omnibus Sworn Statement prior to notice of award.

DEC. 02 2024

THE BIDS AWARDS COMMITTEE:

Having carefully read and accepted your Terms and Conditions, including the technical specifications, I/We offer to supply/deliver the item/s as noted above.

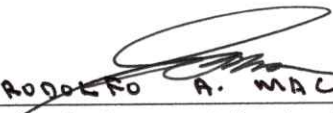
RODOLFO A. MACASPAL

Supplier's authorized representative signature over printed name

Designation: FIRM OWNER

Contact No.: 0908-340-8346

Email Address.: -



BAC CANVASSER

May

Republic of the Philippines
Department of Budget and Management
PROCUREMENT SERVICE

CERTIFICATE OF PHILGEPS REGISTRATION
(Platinum Membership)

THIS IS TO CERTIFY THAT

RODMAC CONSTRUCTION AND TRADING

M.H Del Pilar St. Sta. Cruz,
Lubao, Pampanga, Region III, Philippines

is registered in the Philippine Government Electronic Procurement System (PhilGEPS) on 29-Jan-2016 pursuant to Section 8.5.2 of the Revised Implementing Rules and Regulations of Republic Act No. 9184, otherwise known as the Government Procurement Reform Act.

This further certifies that **RODMAC CONSTRUCTION AND TRADING** has submitted the required eligibility documents in the PhilGEPS Supplier Registry as listed in Annex A, which document is attached hereto and made an integral part hereof.

For the purpose of updating this Certificate, all Class "A" eligibility documents covered by Section 8.5.2 of the Revised Implementing Rules and Regulations of Republic Act No. 9184 supporting the veracity, authenticity and validity of this Certificate shall remain current and updated. The failure by the prospective Bidder to update this Certificate with the current and updated Class "A" eligibility documents shall result in the automatic suspension of its validity until such time that all of the expired Class "A" eligibility documents has been updated.

By submitting this Certificate, the Bidder certifies:

1. the authenticity, genuineness, validity, and completeness of the copy of the original eligibility documents submitted;
2. the veracity of the statements and information contained therein;
3. that the Certificate is not a guaranty that the named registrant will be declared eligible without first being determined to be such for that particular bidding, nor is it an evidence that the Bidder has passed the post-qualification stage; and
4. that any finding of concealment, falsification, or misrepresentation of any of the eligibility documents submitted, or the contents thereof shall be a ground for disqualification from further participation in the bidding process, without prejudice to the imposition of appropriate administrative, civil and criminal penalty in accordance with the laws.

This Certificate is valid until 07-Feb-2025

Issued this 09th day of January 2024.

This is a system generated certificate. No signature is required.



Documentary Stamp Tax Paid Php 30.00
Certificate Reference No: 201601-160281-528660706
Amended Date as of June 11, 2024 11:28 am

REMINDERS ¹

- *The PhilGEPS office shall not determine the eligibility of merchants. The PhilGEPS office's evaluation of the eligibility requirements shall be for the sole purpose of determining the approval or disapproval of the merchant's application for registration.*
- *A merchant's registration and membership in the GOP-OMR is neither contract-specific nor understood to be tantamount to a finding of eligibility. Neither shall the merchant's successful registration in the GOP-OMR be relied upon to claim eligibility for the purpose of participation in any public bidding.*
- *The determination of the eligibility of merchants, whether registered with the GOP-OMR or not, shall remain with the Bids and Awards Committee (BAC). The BAC's determination of validity of the eligibility requirements shall be conclusive to enable the merchant to participate in the public bidding process.*

List of Eligibility Documents

of
RODMAC CONSTRUCTION AND TRADING
 M.H Del Pilar St. Sta. Cruz,
 Lubao, Pampanga, Region III, Philippines

<p>DTI Certificate</p>	<p>DTI Certificate Number : 1341940 Issued By / Signatory : Ramon M. Lopez Registration Date : 03-Jan-2020 Expiration Date : 07-Feb-2025</p>
<p>Mayors Permit</p>	<p>Expiration Date : 31-Dec-2024 Permit Number : 2024 00083 Place of Issue : LUBAO PAMPANGA Issued By / Signatory : HON. ESMERALDA G. PINEDA Issuance Date : 11-Jan-2023</p>
<p>Tax Clearance</p>	<p>Expiration Date : 12-Feb-2025 TCC Number : 04-21B-02-12-R0263-2024-M Issued By / Signatory : JOSEPHINE B PARAGAS Issuance date : 12-Feb-2024</p>
<p>Audited Financial Statement</p>	<p>Date of Filing : 11-Apr-2024 Current Asset : 56,713,891.00 Total Asset : 5,673,891.00 Current Liabilities : 53,882.00 Total Liabilities : 53,882.00 Name of Auditor : Ian D. David BIR RDO Code : 21B</p>
<p>PCAB License</p>	<p>Expiration Date : 29-Jan-2025 Issued By / Signatory : ERNI G. BAGGAO Issuance Date : 01-Jul-2022 License Number : 39965 License First Issue Date : 29-Jan-2016 Principal Classification : GENERAL BUILDING Category : D</p>

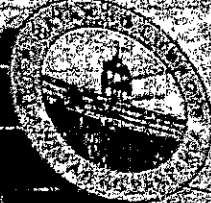

Republic of the Philippines
Province of Pampanga
Municipality of Lubao

RENEWAL

PERMIT NO. 2024-00083

BUSINESS PLATE NO. 0437

MAYOR'S PERMIT

This certifies that

RODMAC CONSTRUCTION AND TRADING

Business Address: #11 M H DEL PILAR, STA CRUZ, LUBAO

Taxpayer's Name: RODOLFO A. MACASPAC

Contact No: 09484640726

Form of Ownership: SINGLE PROPRIETORSHIP

Nationality: FIL

has been granted PERMIT to operate above-cited business/es pursuant to the REVENUE TAX CODE of LUBAO, PROVINCE OF PAMPANGA and after payment of taxes, fees and other regulatory charges and subject to the compliance of such other laws, ordinances and related administrative regulations.

2024

This permit is valid up to December 31, 2024, renewable on or before January 20 of each year unless sooner evoked.

Bin No. 01948-2015-000378

OR No. 587589

OR Date 11/01/2022

Reg. Paid 11/01/2022

CONSTRUCTION SVCS
RETAILER (TRADING)

Approved by

HON. JAY B. MONTEMAYOR
ACTING MUNICIPAL MAYOR

HON. ESMERALDA G. BUNEDA
MUNICIPAL MAYOR

LEVEL UP Lubao

Efficient Service Must Involve Equality

Telephone/Fax No : (045) 971-6276

Email : info@lubao.gov.ph / Website : http://www.lubao.gov.ph

Printed date: 2024-01-04 09:42:53

POSITION/TITLE



Republic of the Philippines
Province of Pampanga

Bids and Awards Committee

Provincial Capitol, City of San Fernando, (P) / (045) 435-5901

DEC 0 2 2024

RFQ No. **241229**

P.R. No. / Date / End User / Purpose:

(24-5724 11/13/2024 PROVINCIAL ENGINEER'S OFFICE To supply materials including installation for Three (3) Units Deep Well at Palimpe, Masantol, Pampanga as per approved Program of Work, Plans and Specifications.)

REQUEST FOR QUOTATION

Small Value Procurement

Company Name: _____
Address: _____
Tel. No.: _____

Please quote your lowest price for the requirements listed hereunder subject to the Terms and Conditions stated below and submit to this Office duly signed by you or your representative not later than **9:00 a.m. DEC: 0 6 2024**

APPROVED BUDGET FOR
THE CONTRACT (ABC):
Php 318,894.03

FRANCIS V. MASLOG
CHAIRPERSON
Bids and Awards Committee

TERMS AND CONDITIONS

- All quotations may be typewritten or handwritten, placed in a sealed envelope.
- All quotations shall be valid for one hundred twenty (120) calendar days from the deadline of the submission of the same.
- Any erasures or overwriting shall be valid only if they are signed or initialed by the supplier or its authorized representative.
- Interested suppliers are required to submit their valid current Mayor's Permit, PhilGEPs Registration Number, and Income/BIR Tax Return (for ABCs above P500,000.00) upon submission of quotation. In lieu of the Mayor's Permit and PhilGEPs Registration Number, the PhilGEPs Certificate of Platinum Membership may be submitted. For new businesses, submit the BIR Certificate of Registration and latest quarterly return or percentage tax..
- The applicable rate for late deliveries is one tenth (1/10) of one percent (1%) of the cost of the unperformed portion for everyday of delay.
- The Provincial Government of Pampanga reserves the right to accept or reject any quotation, and to annul the procurement process and reject all quotations at any time prior to contract award, without thereby incurring any liability to the affected supplier/s.
- The PGP also reserves the right to waive any required formality in the proposals received, and select the proposal which it determine to be the most advantageous to the government.

Item No.	Qty	Unit	Item Description	Unit Price	Total Price
1	9	pcs	2" GI Pipe		
2	39	pcs	1-1/4" GI Pipe		
3	9	pcs	1" GI Pipe		
4	9	pcs	2" GI Coupling		
5	39	pcs	1-1/4" Coupling		
6	9	pcs	1" Coupling		
7	3	set	Hand Pump Set		
8	12	bags	Cement		
9	1	cu.m	Sand		
10	1.50	cu.m	Gravel		
11	24	pcs	10mm Reinforcing Steel Bars		
12	1	l.s	Drilling and Installation Cost		

Total Lot Price

Note: The winning supplier shall submit a duly signed and notarized Omnibus Sworn Statement prior to notice of award.

DEC 0 2 2024

THE BIDS AWARDS COMMITTEE:

Having carefully read and accepted your Terms and Conditions, including the technical specifications, I/We offer to supply/deliver the item/s as noted above.

Supplier's authorized representative signature over printed name

Designation: _____

Contact No.: _____

Email Address.: _____

BAC CANVASSER

May



PhilGEPS

Philippine Government Electronic Procurement System

Central Portal for
Philippine Government
Procurement Opportunities

[Help](#)

Bid Notice Abstract

Request for Quotation (RFQ)

Reference Number 11562914
Procuring Entity PROVINCE OF PAMPANGA
Title PR# 24-5724- PEO- TO SUPPLY MATERIALS INCLUDING INSTALLATION FOR THREE UNITS DEEP WELL
Area of Delivery Pampanga

Solicitation Number:	RFQ 241229	Status	Active
Trade Agreement:	Implementing Rules and Regulations	Associated Components	1
Procurement Mode:	Negotiated Procurement - Small Value Procurement (Sec. 53.9)	Bid Supplements	0
Classification:	Goods	Document Request List	0
Category:	Hardware and Construction Supplies	Date Published	03/12/2024
Approved Budget for the Contract:	PHP 318,894.03	Last Updated / Time	03/12/2024 00:00 AM
Delivery Period:		Closing Date / Time	06/12/2024 09:00 AM
Client Agency:			
Contact Person:	Julie Ann Caballa Bac Secretariat Member Capitol Compound, City of San Fernando, Pampanga. San Fernando City Pampanga Philippines 2000 63-045-4355901 bac@pampanga.gov.ph		

Description

Please quote your lowest price for the requirements listed hereunder subject to the Terms and Conditions stated and submit to this office duly signed not later than 9:00 am. of December 6, 2024.

Note: Interested suppliers are required to submit a VALID current Mayor's Permit Income/BIR Tax Return and PhilGEPS Registration Number upon submission of quotation.

Created by Julie Ann Caballa
Date Created 02/12/2024

The PhilGEPS team is not responsible for any typographical errors or misinformation presented in the system. PhilGEPS only displays information provided for by its clients, and any queries regarding the postings should be directed to the contact person/s of the concerned party.



CERTIFICATION

THIS IS TO CERTIFY that the projects stated below are incorporated in SP Resolution No. 8805, to wit:

PROJECT NAME	APPROVED BUDGET COST
1.) Construction/Improvement of Ancillary/Support Facility and Connecting Bridge of Pampanga Provincial Hospital Annex- Clark ant Changi Gateway, Clark Global City, Mabalacat, Pampanga	₱14,948,730.75
2.) Improvement/Renovation of Infirmary Building at Capitol Compound, City of San Fernando, Pampanga	₱3,891,717.96
3.) Installation of Three (3) Units Deep Well at Palimpe, Masantol, Pampanga	₱318,894.03
4.) Rehabilitation of San Fernando – Lagundi Road (San Jose Section) at San Jose, City of San Fernando, Pampanga	₱4,213,274.58

Issued on the 31st day of October 2024.

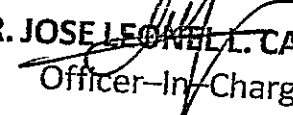
ENGR. JOSE LEONEL L. CASTRO, EnP.
 Officer-In-Charge JCa

Control No.: #C-24-P045





PROVINCIAL ENGINEER'S OFFICE

September 4, 2024

HON. DENNIS G. PINEDA

Governor
Capitol Bldg., City of San Fernando
Pampanga

Thru: **ATTY. CHARLIE G. CHUA**
Provincial Administrator

Dear Sirs:

Submitted for your information and approval the herein Obligation Request, Purchase Request, Program of Work, Detailed Unit Price Analysis, Approved Budget for the Contract, PERT-CPM, and Complete Plans of the project:

1. Installation of Three (3) Units Deep Well at Palimpe, Masantol, Pampanga. (Php 318,894.03)

- Classification: Other Infra Projects
- Funding Source:

Thank you very much.

Respectfully yours,

ENGR. OLIMPIO M. PANGAN
Provincial Engineer

Approved by:

HON. DENNIS G. PINEDA
Governor

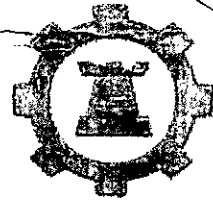
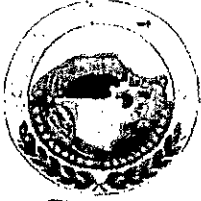

BAGONG PILIPINAS
 Republic of the Philippines
PROVINCE OF PAMPANGA
 City of San Fernando
 peo.pampanga401@gmail.com
 (045) 4353212

PROVINCIAL ENGINEER'S OFFICE

July 26, 2024

HON. DENNIS G. PINEDA
 Governor
 Province of Pampanga

Thru : **ATTY. CHARLIE G. CHUA**
 Provincial Administrator

Province of Pampanga
 Office of the Governor
 RECORDS SECTION
 26 JUL 2024
 RECEIVED
 File 24-4712-233

Dear Governor Pineda;

This is in reference to the on-site joint inspection of this office as the lead team with representatives from PPDO, ENRO and PDRMO regarding the request for the installation of three (3) units Deep Well at Palimpe, Masantol, Pampanga.

According to the report, the inspection was conducted last July 17, 2024 by the team which recommends the approval of the request to resolve the issues on water insufficiency of the barangay and provide easy accessibility to clean water after testing the water potability.

At present, the water provider cannot adequately supply the needs of the residents, hence, the deep well requested is an alternative water source which will be erected strategically at Purok 1, 2 and 3 of the said barangay and will cater more than 300 households. The estimate cost for the installation of the three (3) deep wells with jetmatic hand pump amounting to Php 320,000.00:

Attached herewith are the inspection report with pictures and the estimate for the installation of the requested deep wells.

For your reference and appropriate action.

Thank you.

24-4712 Very truly yours,

FORWARDED TO
 MS. ANGIE
 S.A.G.

ENGR. OLIMPIO M. PANGAN
 Provincial Engineer

Copy Furnished:

MS. ANGELINA S
 Special Assistant I
 PDRMM Officer
 Province of Pampanga

29 JUL 2024

Republic of the Philippines
 PROVINCIAL GOVERNMENT OF PAMPANGA
 City of San Fernando, Pampanga

OBLIGATION REQUEST

No. 11-24-11-8010
 11-15-24

Payee	Provincial Engineer's Office			
Office	Capitol Compound, City of San Fernando, Pampanga			
Address				
Responsibility Center	Particulars	F.P.P.	Account Code	Amount
	To supply Materials including Installation for Three (3) Units Deep Well at Palimpe, Masantol, Pampanga.	1011(u)-13 SB #5		P 318,894.03
Recommending Approval:  OLIMPIO M. PANGAN Provincial Engineer				TOTAL P 318,894.03

A. Certified :

- Charges to appropriation / allotment necessary, lawful and under my direct supervision
- Supporting documents valid, proper and legal

B. Certified :

SP Res. No. 805

Existence of available appropriation

Printed Name: **DENNIS G. PINEDA**
 Position: Governor
 Signature: *By the Authority of the Governor*
 Printed Name: **Atty. CHARME G. CHUA**
 Position: Provincial Administrator
 Head, Requesting Office/Authorized Representative

Signature: *M. -*
 Printed Name: **RIMA K. BONDOC**
 Position: Provincial Budget Officer
 Head, Budget Unit/Authorized Representative

318,894.03
 1115724

-Republic of the Philippines
 PROVINCIAL GOVERNMENT OF PAMPANGA
 City of San Fernando, Pampanga

OBLIGATION REQUEST

No.

Payee				
Office	Provincial Engineer's Office			
Address	Capitol Compound, City of San Fernando, Pampanga			
Responsibility Center	Particulars	F.P.P.	Account Code	Amount
	To supply Materials including Installation for Three (3) Units Deep Well at Palimpe, Masantol, Pampanga.			P 318,894.03
<i>Recommending Approval:</i>  OLIMPIO M. PANGAN Provincial Engineer				
TOTAL P				318,894.03

A. Certified :

- Charges to appropriation / allotment necessary, lawful and under my direct supervision
- Supporting documents valid, proper and legal

B. Certified :

Existence of available appropriation

Printed Name	DENNIS G. PINEDA	Printed Name	RIMA K. BONDOC
Position	Governor	Position	Provincial Budget Officer
Signature	<i>By the Authority of the Governor</i>	Signature	
Printed Name	Atty. CHARVIE G. CHUA	Printed Name	RIMA K. BONDOC
Position	Provincial Administrator	Position	Provincial Budget Officer
	Head, Requesting Office/Authorized Representative		Head, Budget Unit/Authorized Representative

PURCHASE REQUEST

Provincial Government of Pampanga

(Handwritten initials)

PR.NO. 24-5724 Date: 11-13-2024

SAI No. _____ Date: _____

ALOBS No. _____ Date: _____

Subject to the attachment of signed approved & supplemental App

Item Description	Estimated Unit Cost	Estimated Cost
ems to be Accomplished:		
	P 3,381.30	P 30,431.70
	P 2,006.55	P 78,255.45
	P 1,433.25	P 12,899.25
	P 245.70	P 2,211.30
	P 128.70	P 5,019.30
	P 99.45	P 895.05
	P 7,265.70	P 21,797.10
	P 269.10	P 3,229.20
	P 877.50	P 877.50
	P 1,521.00	P 2,281.50
	P 200.07	P 4,801.68
	P 156,195.00	P 156,195.00
Total Cost		P 318,894.03

X-X-X- X-X-X-X-X-X-X-X-X-X-X-X-X-X-X-X

(Handwritten initials)

To supply Materials including Installation for **Three (3) Units Deep Well at Palimpe, Masantol, Pampanga** as per approved Program of Work, Plans and Specifications.

Requested By:

Cash Availability:

Approved By:

Hon. DENNIS G. PINEDA
Governor

By the Authority of the Governor :

(Signature)
OLIMPIO M. PANGAN
Provincial Engineer

(Signature)
PIA MAGDALENA D. QUIBAL
Provincial Treasurer

(Signature)
Atty. CHARLIE G. CHUA
Provincial Administrator

(Handwritten mark)

PURCHASE REQUEST

Provincial Government of Pampanga

Department : **Provincial Engineer's Office** PR.NO. 24-5724 Date: 11-13-2024
 Section : SAI No. _____ Date: _____
 ALOBS No. _____ Date: _____

Unit of Issue	Quantity	Item Description	Estimated Unit Cost	Estimated Cost
Items to be Accomplished:				
pcs	9.00	2" GI Pipe	P 3,381.30	P 30,431.70
pcs	39.00	1-1/4" GI Pipe	P 2,006.55	P 78,255.45
pcs	9.00	1" GI Pipe	P 1,433.25	P 12,899.25
pcs	9.00	2" GI Coupling	P 245.70	P 2,211.30
pcs	39.00	1-1/4" Coupling	P 128.70	P 5,019.30
pcs	9.00	1" Coupling	P 99.45	P 895.05
set	3.00	Hand Pump Set	P 7,265.70	P 21,797.10
bags	12.00	Cement	P 269.10	P 3,229.20
cu.m	1.00	Sand	P 877.50	P 877.50
cu.m	1.50	Gravel	P 1,521.00	P 2,281.50
pcs	24.00	10mm Reinforcing Steel Bars	P 200.07	P 4,801.68
l.s.	1.00	Drilling and Installation Cost	P 156,195.00	P 156,195.00
		X-X-X- X-X-X-X-X-X-X-X-X-X-X-X-X-X-X-X-X		
Total Cost				P 318,894.03

To supply Materials including Installation for **Three (3) Units Deep Well at Palimpe, Masantol, Pampanga** as per approved Program of Work, Plans and Specifications.

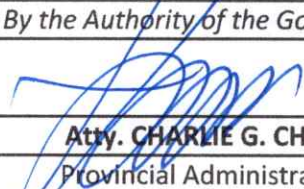
<i>Requested By:</i>	<i>Cash Availability:</i>	<i>Approved By:</i>
 OLIMPIO M. PANGAN Provincial Engineer	PIA MAGDALENA D. QUIBAL Provincial Treasurer	Hon. DENNIS G. PINEDA Governor
		<i>By the Authority of the Governor :</i>
		 Atty. CHARLIE G. CHUA Provincial Administrator

Republic of the Philippines
 PROVINCE OF PAMPANGA
 City of San Fernando
OFFICE OF THE PROVINCIAL ENGINEER

PROGRAM OF WORKS

Project Name	: <u>Installation of Three (3) Units Deep Well</u>	Date	: <u>September 3, 2024</u>
		Road Width	: _____
		Pavement Width	: _____
Location	: <u>Palimpe, Masantol, Pampanga</u>	Bridge Width	: _____
Classification	: _____	Type of Substructure	: _____
Appropriation	: <u>P 318,894.03</u>	Type of Superstructure	: _____
Source of Fund	: _____	No. of Span / Storey	: _____
Limits	: _____	No. of Pier : _____	No. of Abutt.: _____
Net Length	: _____	Starting Date	: _____
Project Description	: <u>Materials Only</u>	No. of Days to Complete	: _____

Description of Work to be done	% Wt.	Equipment Description	NUMBER	
			Needed	Available
Drilling and Installation of Three (3) Units Deep Well with Catch Basin	100.000			
TOTAL	100.00 %			

ESTIMATED COST OF PROPOSED WORK					
Item	Description	Unit	Quantity	Direct Cost	
I	Drilling and Installation of Three (3) Units Deep Well with Catch Basin	l.s.	1.00	272,559.00	

Materials Cost	: P	272,559.00	Direct Cost	: P	272,559.00
Freight and Other Cost Factor	: P	32,707.08	Indirect Cost	: P	46,335.03
Tax	: P	13,627.95	TOTAL BUDGET COST	: P	318,894.03
TOTAL BUDGET COST	: P	318,894.03			

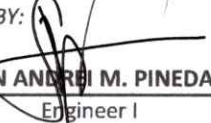
PREPARED BY: 
LAN ANDREI M. PINEDA
 Engineer I

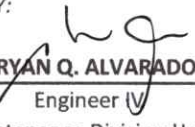
CHECKED BY: 
BRYAN Q. ALVARADO
 Engineer IV
 Maintenance Division Head

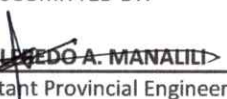
VERIFIED & SUBMITTED BY: 
WILFREDO A. MANALILI
 Assistant Provincial Engineer

RECOMMENDING APPROVAL: 
OLIMPIO M. PANGAN
 Provincial Engineer

APPROVED BY: 
Hon. DENNIS G. PINEDA
 Governor

BY THE AUTHORITY OF THE GOVERNOR: 
Atty. CHARLIE G. CHUA
 Provincial Administrator

Republic of the Philippines
 PROVINCE OF PAMPANGA
 City of San Fernando
OFFICE OF THE PROVINCIAL ENGINEER

PROGRAM OF WORKS

Project Name	: <u>Installation of Three (3) Units Deep Well</u>	Date	: <u>September 3, 2024</u>
		Road Width	: _____
		Pavement Width	: _____
Location	: <u>Palimpe, Masantol, Pampanga</u>	Bridge Width	: _____
Classification	: _____	Type of Substructure	: _____
Appropriation	: <u>P 318,894.03</u>	Type of Superstructure	: _____
Source of Fund	: _____	No. of Span / Storey	: _____
Limits	: _____	No. of Pier : _____	No. of Abutt.: _____
Net Length	: _____	Starting Date	: _____
Project Description	: <u>Materials Only</u>	No. of Days to Complete	: _____

Description of Work to be done	% Wt.	Equipment Description	NUMBER	
			Needed	Available
Drilling and Installation of Three (3) Units Deep Well with Catch Basin	100.000			
TOTAL	100.00 %			

ESTIMATED COST OF PROPOSED WORK					
Item	Description	Unit	Quantity	Direct Cost	
I	Drilling and Installation of Three (3) Units Deep Well with Catch Basin	l.s.	1.00	272,559.00	

Materials Cost	: P	272,559.00		Direct Cost	: P	272,559.00
Freight and Other Cost Factor	: P	32,707.08		Indirect Cost	: P	46,335.03
Tax	: P	13,627.95		TOTAL BUDGET COST	: P	318,894.03
TOTAL BUDGET COST	: P	318,894.03				

PREPARED BY: 
IAN ANDREI M. PINEDA
 Engineer I

CHECKED BY: 
BRYAN Q. ALVARADO
 Engineer IV
 Maintenance Division Head

VERIFIED & SUBMITTED BY: 
WILFREDO A. MANALILI
 Assistant Provincial Engineer

RECOMMENDING APPROVAL: 
OLIMPIO M. PANGAN
 Provincial Engineer

APPROVED BY: 
Hon. DENNIS G. PINEDA
 Governor

BY THE AUTHORITY OF THE GOVERNOR: 
Atty. CHARLIE G. CHUA
 Provincial Administrator

PROVINCE OF PAMPANGA
 City of San Fernando, Pampanga
OFFICE OF THE PROVINCIAL ENGINEER

APPROVED BUDGET FOR THE CONTRACT

Name of Project : Installation of Three (3) Units Deep Well

Location : Palimpe, Masantol, Pampanga

Contract Duration :

ITEM NO.	DESCRIPTION	QTY	UNIT	ESTIMATED DIRECT COST		INDIRECT COST		TOTAL INDIRECT COST	TOTAL COST	UNIT COST
				MATERIAL COST		FREIGHT AND OTHER COST FACTOR (12%)	TAX (5%)			
1	Drilling and Installation of Three (3) Units Deep Well with Catch Basin	1.00	l.s.	272,559.00		32,707.08	13,627.95	46,335.03	P 318,894.03	318,894.03
	TOTAL			272,559.00		32,707.08	13,627.95	46,335.03	P 318,894.03	

Prepared By :

LAN ANBER M. PINEDA
 Engineer I

Checked By :

BRYAN O. ALVARADO
 Engineer IV
 Maintenance Division Head

Verified & Submitted By :

WILFREDO A. MANAHT
 Assistant Provincial Engineer

Recommending Approval :

OLIMPIO M. PANGAN
 Provincial Engineer

Approved By :

HON. DENNIS G. PINEDA
 By the Authority of the Governor :

NITY CHARLENE G. CHUA
 Provincial Administrator

PROVINCE OF PAMPANGA
 City of San Fernando, Pampanga
OFFICE OF THE PROVINCIAL ENGINEER

APPROVED BUDGET FOR THE CONTRACT

Name of Project : Installation of Three (3) Units Deep Well

Location : Palimpe, Masantol, Pampanga

Contract Duration :

ITEM NO.	DESCRIPTION	QTY	UNIT	ESTIMATED DIRECT COST		INDIRECT COST		TOTAL INDIRECT COST	TOTAL COST	UNIT COST
				MATERIAL COST		FREIGHT AND OTHER COST FACTOR (12%)	TAX (5%)			
1	Drilling and Installation of Three (3) Units Deep Well with Catch Basin	1.00	l.s.	272,559.00		32,707.08	13,627.95	46,335.03	P 318,894.03	318,894.03
	TOTAL			272,559.00		32,707.08	13,627.95	46,335.03	P 318,894.03	

Prepared By :

DAN ANIBAL M. PINEDA
 Engineer I

Checked By :

BRYAN O. ALVARADO
 Engineer IV
 Maintenance Division Head

Verified & Submitted By :

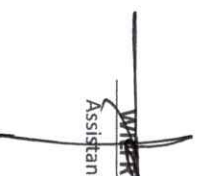
MARKEDO A. MANALILI
 Assistant Provincial Engineer

Recommending Approval :

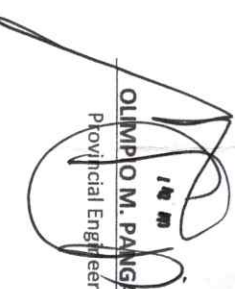
OLIMPIO M. PANGAN
 Provincial Engineer

Approved By :

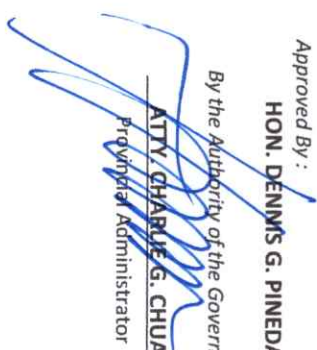
HON. DENNIS G. PINEDA
 By the Authority of the Governor :

ATTY. CHARLES G. CHUA
 Provincial Administrator

Project: Installation of Three (3) Units Deep Well at Palimpe, Masantol, Pampanga

GI PIPE SCHEDULE 40 (6m)

DIAMETER	QTY (pcs)	UNIT COST	TOTAL
2"	9.00	2,890.00	26,010.00
1-1/4"	39.00	1,715.00	66,885.00
1"	9.00	1,225.00	11,025.00
Material Cost			103,920.00

PHP

GI COUPLING SCHEDULE 40

DIAMETER	QTY (pcs)	UNIT COST	TOTAL
2"	9.00	210.00	1,890.00
1-1/4"	39.00	110.00	4,290.00
1"	9.00	85.00	765.00
Material Cost			6,945.00

PHP

HAND PUMP

QTY (set)	UNIT COST	TOTAL
3.00	6,210.00	18,630.00
Material Cost		18,630.00

PHP

CEMENT

QTY (bags)	UNIT COST	TOTAL
12.00	230.00	2,760.00
Material Cost		2,760.00

PHP

SAND

QTY (cu.m)	UNIT COST	TOTAL
1.00	750.00	750.00
Material Cost		750.00

PHP

GRAVEL		
QTY (cu.m)	UNIT COST	TOTAL
1.50	1,300.00	1,950.00
Material Cost		1,950.00
		PHP

10mm REINFORCING STEEL BARS		
QTY (pcs)	UNIT COST	TOTAL
24.000	171.00	4,104.00
Material Cost		4,104.00
		PHP

<i>MATERIAL COST:</i>	139,059.00	PHP
<i>DRILLING AND INSTALLATION COST:</i>	133,500.00	PHP
<i>FREIGHT AND OTHER COST FACTOR (12%)</i>	32,707.08	PHP
<i>TAX (5%)</i>	13,627.95	PHP

TOTAL BUDGET COST	318,894.03	PHP
--------------------------	-------------------	------------

Prepared by:

 ENGR. LAN ANDREI M. PINEDA
 Engineer I

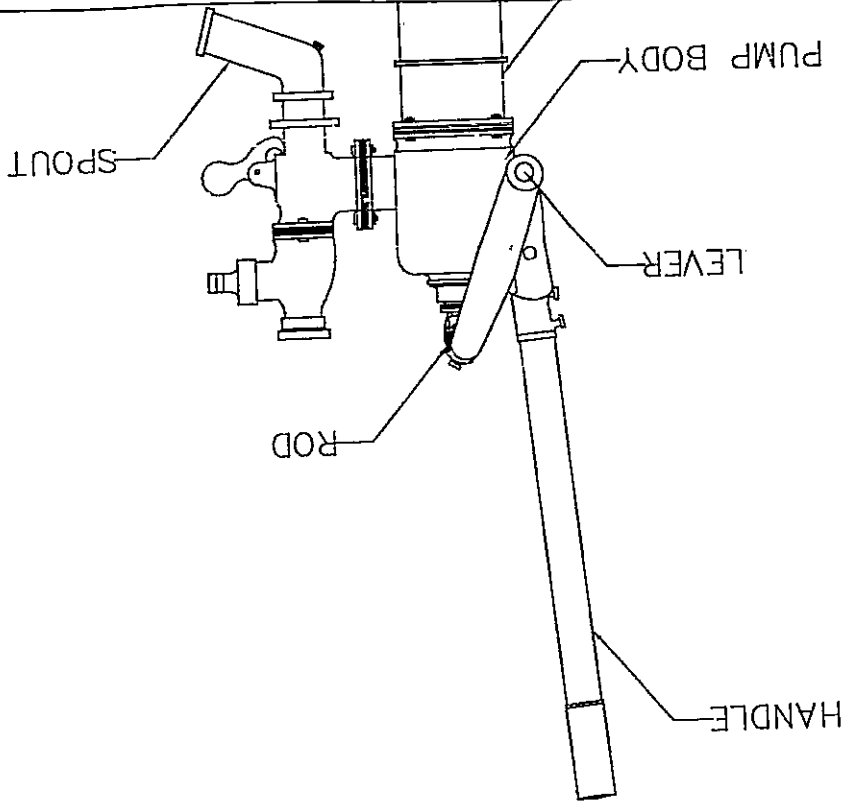

10mm ϕ H
10mm ϕ BARS
@ 400mm O.C. B

HAN

CATCH BASIN (S